



# FireMaster<sup>®</sup> Pipework Jet and Hydrocarbon fire protection



# Jet fire protection of steel piping



FireMaster® Marine Plus blanket has been fire tested for the fire protection of pipes for up to 200 minutes in hydrocarbon fires according to the EN13381-4 standard.

The system consists of FireMaster® Marine Plus blanket 128kg/m<sup>3</sup> density wrapped around the pipe and held in place with steel wire. Exterior cladding is applied for mechanical and weather protection.

The same system is also fire tested against jet fires of 60 minutes duration to the ISO 22899-1 fire test standard. To provide protection against the impinging jet, a stainless steel cladding is installed over the blanket. Two different grades of steel have been jet-fire tested for maximum flexibility in design.

The system has been demonstrated to have blast resistance to 0.5 bar overpressure. See page 65 for details.



Our systems provide a lower-cost alternative to custom-made jacket systems and are:

- Lightweight
- Easy to install
- Easy to engineer and modify on site, requiring minimal site surveying
- Cost-effective



# Jet fire protection of steel piping

Steel pipe system. Explosion resistance to 0.5 bar

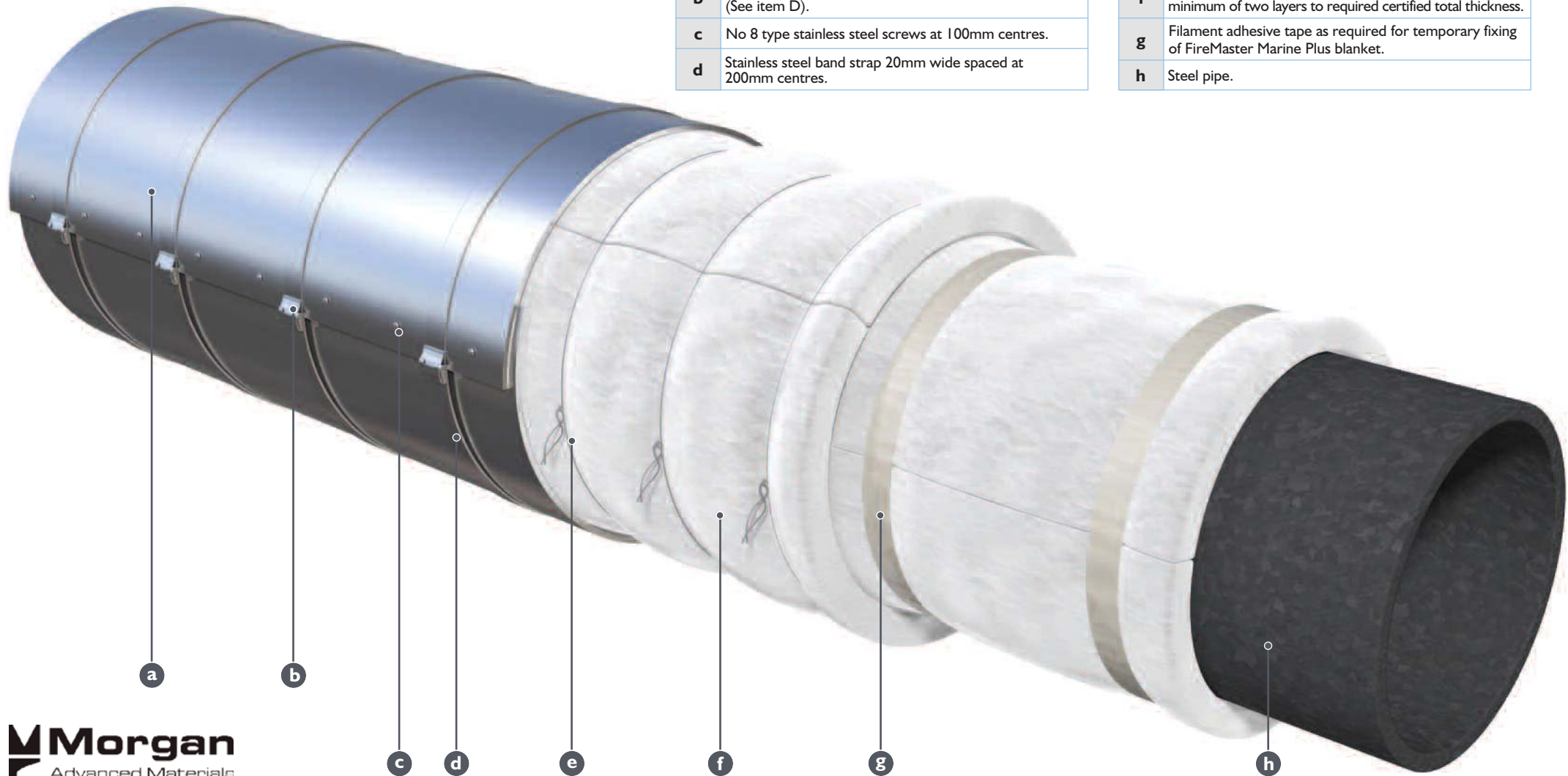

<b>a</b>	Steel Cladding - for jet fire either: 1. 316 grade 0.7mm 2. 304 grade 0.6mm
<b>b</b>	Stainless steel clips used to retain steel band strap (See item D).
<b>c</b>	No 8 type stainless steel screws at 100mm centres.
<b>d</b>	Stainless steel band strap 20mm wide spaced at 200mm centres.

<b>e</b>	Steel tie wire for retention of FireMaster Marine Plus blanket spaced at nominal 50mm from blanket edge and at centre of blanket with maximum of 300mm spacing.
<b>f</b>	FireMaster Marine Plus blanket 128 kg/m <sup>3</sup> installed in a minimum of two layers to required certified total thickness.
<b>g</b>	Filament adhesive tape as required for temporary fixing of FireMaster Marine Plus blanket.
<b>h</b>	Steel pipe.

## Steel pipe system - detail view

<b>a</b>	Steel Cladding - for jet fire either: 1. 316 grade 0.7mm 2. 304 grade 0.6mm
<b>b</b>	Overlap on steel cladding of 75mm sealed with Dow Corning FireStop 700 mastic or equivalent.
<b>c</b>	No 8 type stainless steel screws at 100mm centres.
<b>d</b>	Stainless steel band strap 20mm wide spaced at 200mm centres.
<b>e</b>	Steel tie wire for retention of FireMaster Marine Plus blanket spaced at nominal 50mm from blanket edge and at centre of blanket with maximum of 300mm spacing.
<b>f</b>	FireMaster Marine Plus blanket 128 kg/m <sup>3</sup> installed in a minimum of two layers to required certified total thickness.

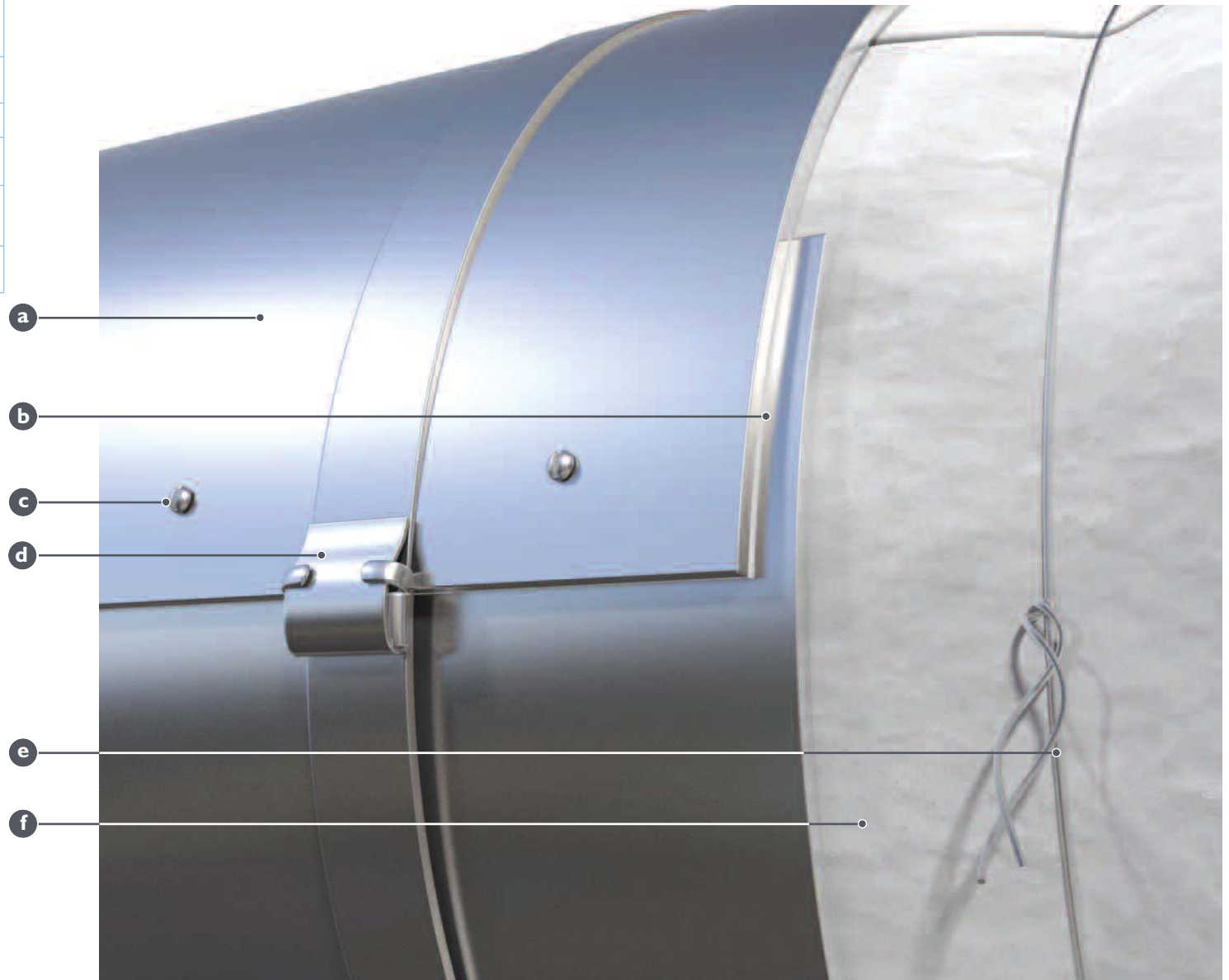



# 180 minute Jet Fire Protection System for steel pipes

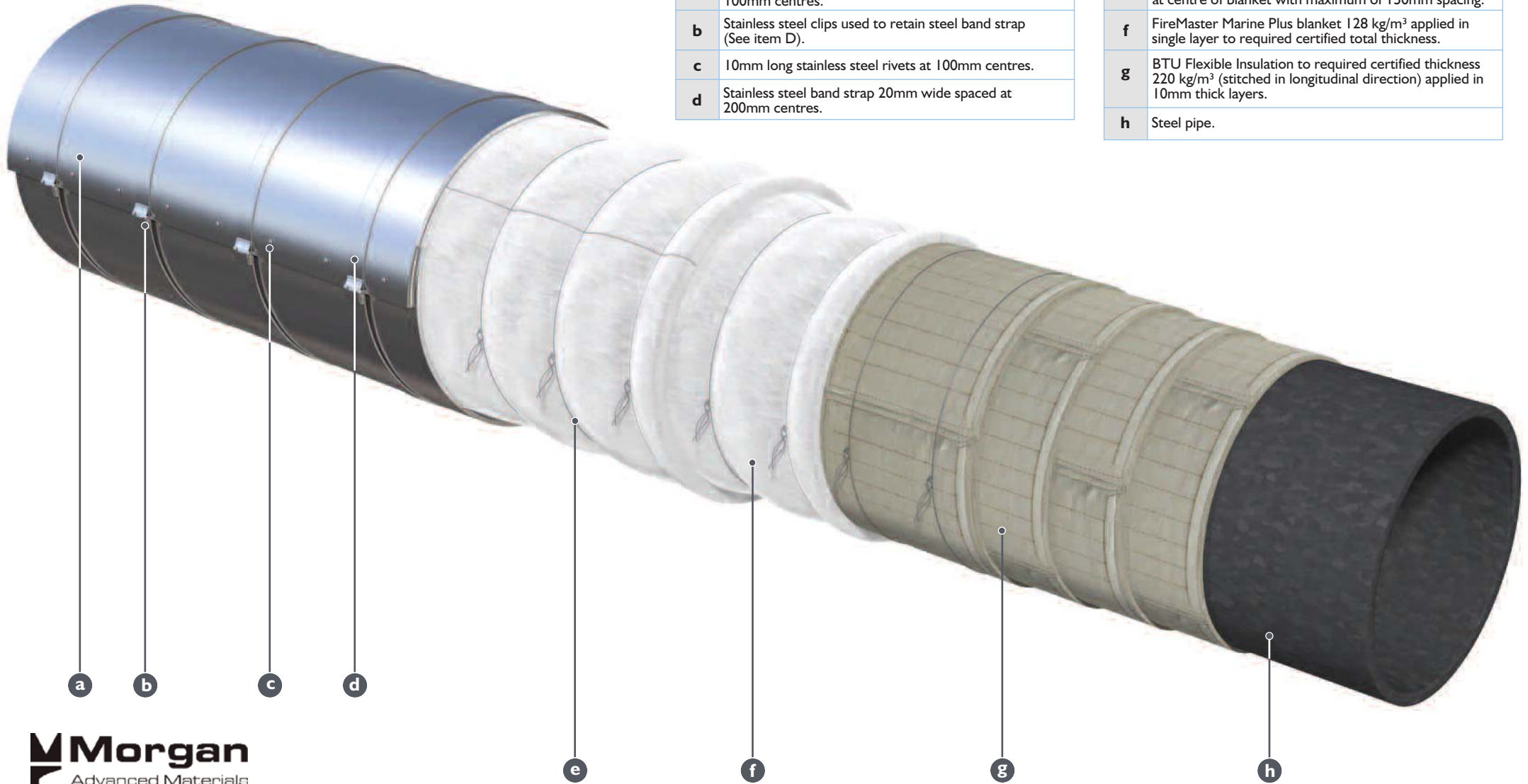

<b>a</b>	Steel Cladding - for jet fire : 304 grade 0.6mm Fixed with 10mm long stainless steel rivets at 100mm centres.
<b>b</b>	Stainless steel clips used to retain steel band strap (See item D).
<b>c</b>	10mm long stainless steel rivets at 100mm centres.
<b>d</b>	Stainless steel band strap 20mm wide spaced at 200mm centres.

<b>e</b>	Steel tie wire for retention of FireMaster Marine Plus blanket spaced at nominal 50mm from blanket edge and at centre of blanket with maximum of 150mm spacing.
<b>f</b>	FireMaster Marine Plus blanket 128 kg/m <sup>3</sup> applied in single layer to required certified total thickness.
<b>g</b>	BTU Flexible Insulation to required certified thickness 220 kg/m <sup>3</sup> (stitched in longitudinal direction) applied in 10mm thick layers.
<b>h</b>	Steel pipe.

## Continuous wrap alternative

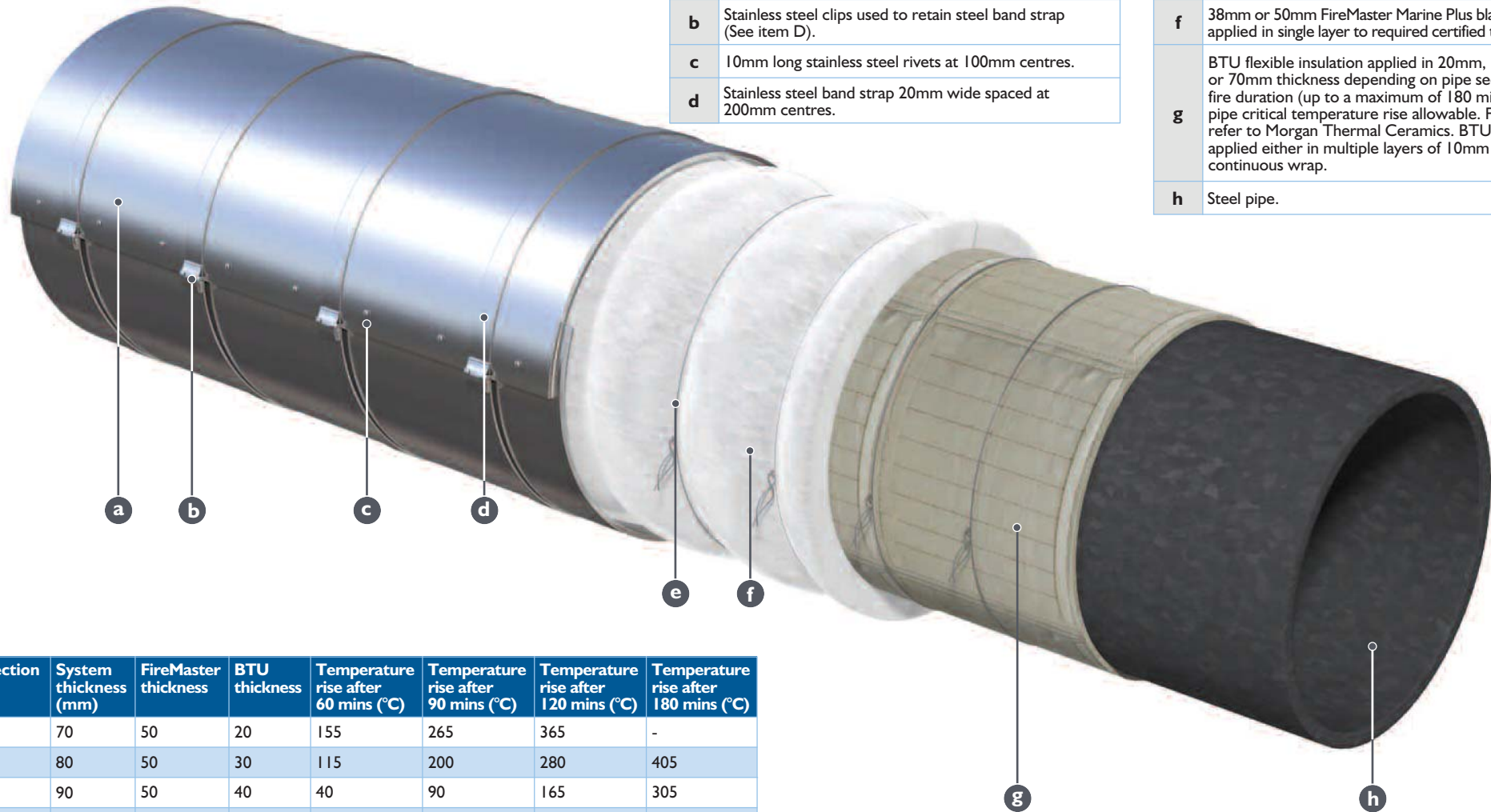

<b>a</b>	Steel Cladding - for jet fire : 304 grade 0.6mm Fixed with 10mm long stainless steel rivets at 100mm centres.
<b>b</b>	Stainless steel clips used to retain steel band strap (See item D).
<b>c</b>	10mm long stainless steel rivets at 100mm centres.
<b>d</b>	Stainless steel band strap 20mm wide spaced at 200mm centres.

<b>e</b>	Steel tie wire for retention of FireMaster Marine Plus blanket spaced at nominal 50mm from blanket edge and at centre of blanket with maximum of 150mm spacing.
<b>f</b>	38mm or 50mm FireMaster Marine Plus blanket 128 kg/m <sup>3</sup> applied in single layer to required certified total thickness.
<b>g</b>	BTU flexible insulation applied in 20mm, 30mm, 40mm or 70mm thickness depending on pipe section factor, fire duration (up to a maximum of 180 minutes) and pipe critical temperature rise allowable. For full details refer to Morgan Thermal Ceramics. BTU Flexible is applied either in multiple layers of 10mm or as a continuous wrap.
<b>h</b>	Steel pipe.

Pipe section factor (m <sup>-1</sup> )	System thickness (mm)	FireMaster thickness	BTU thickness	Temperature rise after 60 mins (°C)	Temperature rise after 90 mins (°C)	Temperature rise after 120 mins (°C)	Temperature rise after 180 mins (°C)
115	70	50	20	155	265	365	-
113	80	50	30	115	200	280	405
120	90	50	40	40	90	165	305
206	108	38	70	20	50	90	220
254*	70	-	70	145	230	300	415
345	78	38	40	155	310	-	-

\* tested as a drain plug detail see Type Approval Certificate for details

# Examples of FireMaster® JetWrap system on bends

Pipe bends





## Pipe bends - detail view

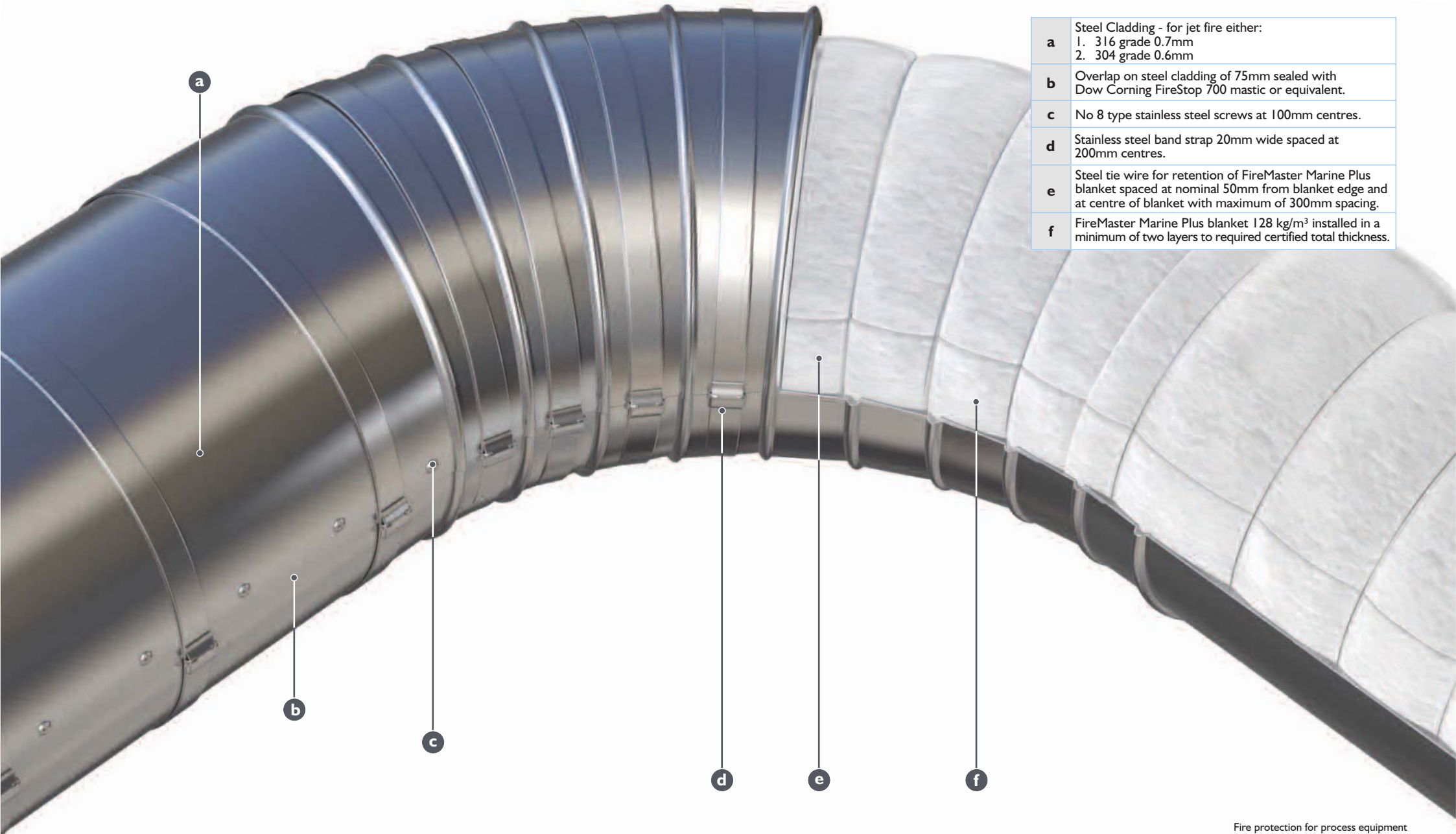

<b>a</b>	Steel Cladding - for jet fire either: 1. 316 grade 0.7mm 2. 304 grade 0.6mm
<b>b</b>	Overlap on steel cladding of 75mm sealed with Dow Corning FireStop 700 mastic or equivalent.
<b>c</b>	No 8 type stainless steel screws at 100mm centres.
<b>d</b>	Stainless steel band strap 20mm wide spaced at 200mm centres.
<b>e</b>	Steel tie wire for retention of FireMaster Marine Plus blanket spaced at nominal 50mm from blanket edge and at centre of blanket with maximum of 300mm spacing.
<b>f</b>	FireMaster Marine Plus blanket 128 kg/m <sup>3</sup> installed in a minimum of two layers to required certified total thickness.

# Jet fire protection of steel piping

Foamglass pipe system. Blast resistance : 0.7 bar

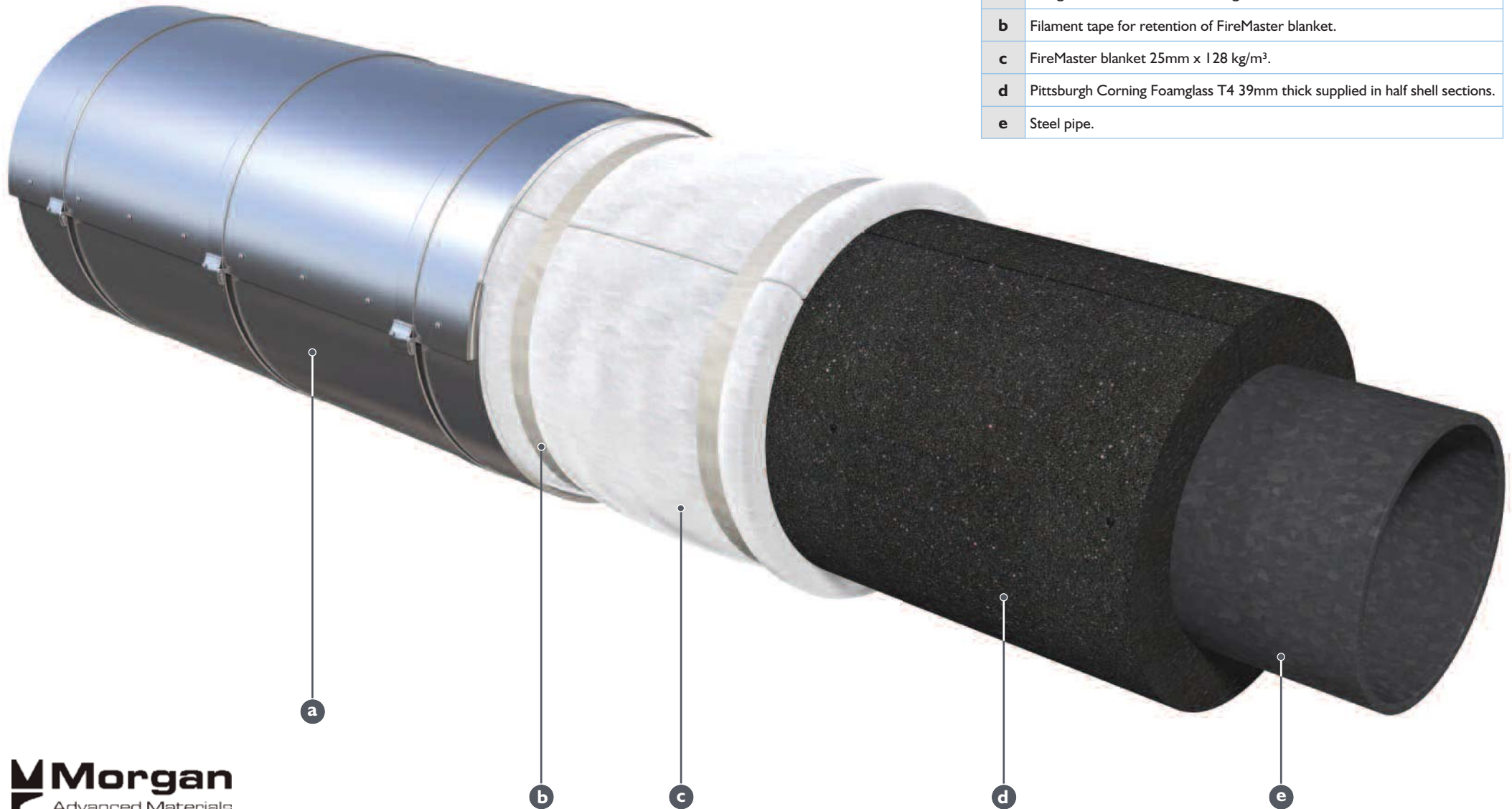

<b>a</b>	316 grade Stainless Steel Cladding 0.7mm thick.
<b>b</b>	Filament tape for retention of FireMaster blanket.
<b>c</b>	FireMaster blanket 25mm x 128 kg/m <sup>3</sup> .
<b>d</b>	Pittsburgh Corning Foamglass T4 39mm thick supplied in half shell sections.
<b>e</b>	Steel pipe.



## Foamglass pipe system - detail view

<b>a</b>	316 grade stainless steel cladding 0.7mm thick.
<b>b</b>	Overlap on steel cladding of 75mm sealed with Dow Corning FireStop 700 mastic or equivalent.
<b>c</b>	No 8 type stainless steel screws at 100mm centres.
<b>d</b>	Stainless steel band strap 20mm wide spaced at 200mm centres.
<b>e</b>	FireMaster blanket 25mm x 128 kg/m <sup>3</sup> .
<b>f</b>	Filament tape for retention of FireMaster blanket.



# FireMaster® pipe fire protection system

## A guide to specification and certification

The thickness of insulation that is required to be applied to pipework to provide fire protection will depend on a number of factors. These are:

1. Fire load and duration
2. Critical temperature specified for the pipe; i.e. the maximum permitted temperature for the pipe during the fire
3. The 'section factor' of the pipe; a relationship of external pipe surface perimeter and pipe wall thickness
4. The initial operating temperature of the pipe

These factors are very important in design of pipe fire insulation systems.

### Critical pipe temperature

Pipework is normally insulated against fire to maintain its temperatures below 400°C, the limit usually applied for structural steel, in order to prevent rupture or collapse. Other temperature limits than this may also be applied. The thickness of fire insulation that must be applied will vary with the pipe critical temperature; increasing as the critical temperature decreases for the same size of pipe.

### Section factor

The section factor relates the surface area of the pipe exposed to fire to the amount of steel in the wall of the pipe available to absorb heat from the fire.

As steel offers a large 'heat sink' effect, increasing wall thickness provides an increased mass of steel to be heated, resulting in a slower rise in temperature. The rate of heat increase also depends on how much heat is input into the pipe. This will vary with the surface area available to absorb heat. As pipe diameter increases, the heated surface area increases. As wall thickness increases, the volume of steel available to absorb heat increases.

The section factor of a pipe is calculated by dividing the outside external pipe surface perimeter by the cross-sectional area of the wall.

### Example:

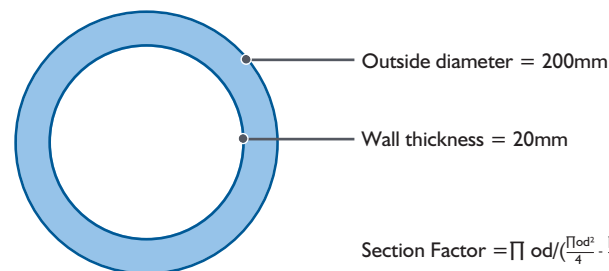

$$\text{Section Factor} = \pi \text{ od} / \left( \frac{\pi \text{od}^2}{4} - \frac{\pi \text{id}^2}{4} \right) = (\pi * 0.2) / (\pi * 0.2^2 / 4 - \pi * 0.16^2 / 4) = 56 \text{m}^{-1}$$

The table below illustrates the effect of section factor on insulation thickness for two different sized pipes:

Pipe serial number	Section factor (m <sup>-1</sup> )	Insulation thickness required to maintain pipe temp. to 400°C for one hour in a hydrocarbon fire
6 inch schedule 120	77	25mm
3 inch schedule 40	205	75mm

Fire testing of pipe fire insulation is designed to relate section factor to insulation thickness for a variety of failure temperatures and this requires a large variety of pipes to be tested. FireMaster Marine Plus blanket has been fully tested on 13 pipes in order to generate the required thickness tables in accordance with Annex E4 of EN 13381-4 fire test procedure for structural steelwork.



### Fire load and duration

The heat flux or temperature to which the pipe is exposed will influence the thickness of insulation required for fire insulation. In general a jet fire is expected to have a higher heat flux than a hydrocarbon pool fire and therefore more insulation will be required when insulating a pipe against a jet fire than a hydrocarbon pool fire.

One problem when determining thickness requirements for jet fire insulation systems is that it is not practical to test the large variety of pipes required to obtain sufficient data to construct thickness versus section factor tables.

The common solution to this problem is to first test a sufficient variety of sizes in a furnace hydrocarbon fire test and then to select at least 2 of the pipes, identically insulated and subject them to a jet fire test. A relationship of temperature rises obtained in each fire scenario can then be made. More than 2 pipes may be required to be jet fire tested depending on the reliability of the relationship.

FireMaster Marine Plus blanket has been tested in accordance with this procedure and the test results used to construct a table of thickness requirement versus section factor for jet fire protection as well as hydrocarbon fire protection.

### Thickness requirements jet fire and hydrocarbon fire

The tables opposite on page 24 compare the thickness requirements for jet and hydrocarbon fire protection of pipes of varying section factor for a critical temperature of 400°C assuming 60 minutes fire duration. For a full range of critical temperatures and time periods reference can be made to the Lloyds Register Type Approval certificate.

Additionally Morgan Thermal Ceramics provides a software package 'SectionWizard' to allow straightforward access to the fire test approved thickness data without the need to calculate section factors or look up tables. More details on SectionWizard can be found on page 71.

**Guidelines on determination of the thickness of FireMaster Marine Plus blanket required in combined jet and hydrocarbon fire protection of pipes**  
ISO 22899-2 (Section 9) provides guidelines on determining the thickness of fire protection required for combined hydrocarbon and jet fires.

This is explained in more detail on page 7 of this manual. The following example illustrates this methodology for pipes fire protected with FireMaster Marine Plus blanket.

**Example: 30 minute initial jet fire followed by a 30 minute hydrocarbon fire - total fire duration of 60 minutes on a 6" (DN 150) schedule 40 pipe.**

Using the fire test data on pipes insulated with FireMaster Marine Plus blanket in hydrocarbon and jet fires, thickness v section factor tables are available for hydrocarbon and jet fires for a wide variety of pipe section factors.

These tables can be used to determine the necessary thicknesses used in the example below or (for maximum accuracy) through use of Morgan Advanced Materials "Section-Wizard" Software.

## A guide to specification and certification

### ISO 22899-2 guidance on combined jet and hydrocarbon fires.

For the combined 30 minute jet fire followed by a 30 minute hydrocarbon fire, ISO 22899-2 guidance is as follows:

1. Select the insulation thickness required for 60 minutes hydrocarbon fire protection
2. Select the insulation thickness required for 30 minutes hydrocarbon fire protection
3. Select the insulation thickness required for 30 minutes jet fire protection
4. Calculate the “erosion factor” of jet versus hydrocarbon fire for the 30 minutes fire protection period by deducting the thickness in (2) from (3) above
5. Add this “erosion factor” to the thickness required for 60 minutes hydrocarbon fire selected in (1) above.

#### For the example above:

6” inch schedule 40 pipe – section factor  $147\text{m}^{-1}$  assumed critical pipe temperature  $400^{\circ}\text{C}$ .

1. Thickness required for 60 minute Hydrocarbon fire = 51 mm
2. Thickness required for 30 minute Hydrocarbon fire = 25 mm
3. Thickness required for 30 minute Jet fire = 38 mm <sup>(1)</sup>
4. “Erosion Factor” (See ISO 22899-2 Section 9) for 30 minute Jet fire =  $38 - 25 = 13\text{mm}$
5. Thickness required for combined fire =  $51 + 13 = 64\text{mm}$ . The nearest standard thickness of FireMaster Blanket to this would be 75 mm (25 + 50 mm).

<sup>1</sup> For  $400^{\circ}\text{C}$  critical temperature on pipes in jet fires use the thickness required for a  $200^{\circ}\text{C}$  critical temperature of the corresponding pipe in a hydrocarbon fire in accordance with the Type Approval of FireMaster Marine Plus Blanket for pipes in jet and hydrocarbon fires. SectionWizard Software can be used to provide exact thickness values if standard tables are not available or do not provide sufficiently precise data.

**Standard supplied thicknesses of FireMaster Marine Plus blanket required to limit the temperature rise of a steel pipe to  $400^{\circ}\text{C}$  in hydrocarbon and jet fires of 60 minutes duration.**

Pipe section factor ( $\text{m}^{-1}$ )	Hydrocarbon fire
$\leq 75$	25mm
76 to 105	38mm
106 to 145	50mm
146 to 200	63mm
201 to 275	75mm
276 to 400	88mm

Pipe section factor ( $\text{m}^{-1}$ )	Jet fire
$\leq 65$	51mm
66 to 85	63mm
86 to 110	75mm
110 to 160	88mm
151 to 205	100mm



# Acoustic insulation properties of FireMaster pipe fire protection system

For insulation intended to be used on piping, generic sound transmission loss values for the insulation material is not sufficient data. Sound transmission loss values must be measured on pipes insulated with the intended insulation system.

Testing for sound transmission loss uses the ISO 15665:2003 insertion loss method. Pipes of 3 different diameters (DN100, DN300 and DN600) insulated with the insulation system are tested. Insertion losses of pipe sizes up to DN1000 can then be extrapolated in accordance with ISO 15665 in order to allow classification for the 3 pipe sizes specified in the standard.

The basic concept of insertion loss testing is straightforward. "Pink noise" in 1/3 octave band over a frequency range of 50 to 10,00Hz is introduced into the 3 pipes which are located in an anechoic chamber. The sound transmission from each pipe into the chamber is then measured. The test is run firstly on a set of uninsulated pipes and then on a set of pipes fitted with the insulation system being investigated. Sound transmission values for the uninsulated and insulated pipes can then be compared to obtain the sound reduction value of the insulation system. The general arrangement of the test is shown in the drawing (right).

Although simple in concept, the acoustic performance of pipe insulation is complicated due to interaction of the pipe and insulation system. Vibration of the pipe at low frequencies is an additional source of noise and transmission of vibrated sound through any external cladding used on the insulation will influence the overall sound transmission loss. The sound transmission loss will vary by pipe diameter (increased surface area can increase sound transmission) and frequency range (low frequency vibration and "drumming" of the system can be significant to low density insulation systems). The properties of cladding materials are also significant.

## Test Performance of FireMaster Pipe Fire Protection System

A series of tests have been run on the system. These have investigated the performance of various thicknesses of FireMaster Marine Plus Blanket with

various thicknesses of steel cladding and also the influence of anti-drumming materials used to improve low frequency sound transmission.

The tested systems and their performance are summarised in Tables 1 to 2 (page 44 - 45). Note that negative values indicate an increase in sound transmission (i.e. "worse" sound reduction) compared to the un-insulated pipe case, this is not unusual.

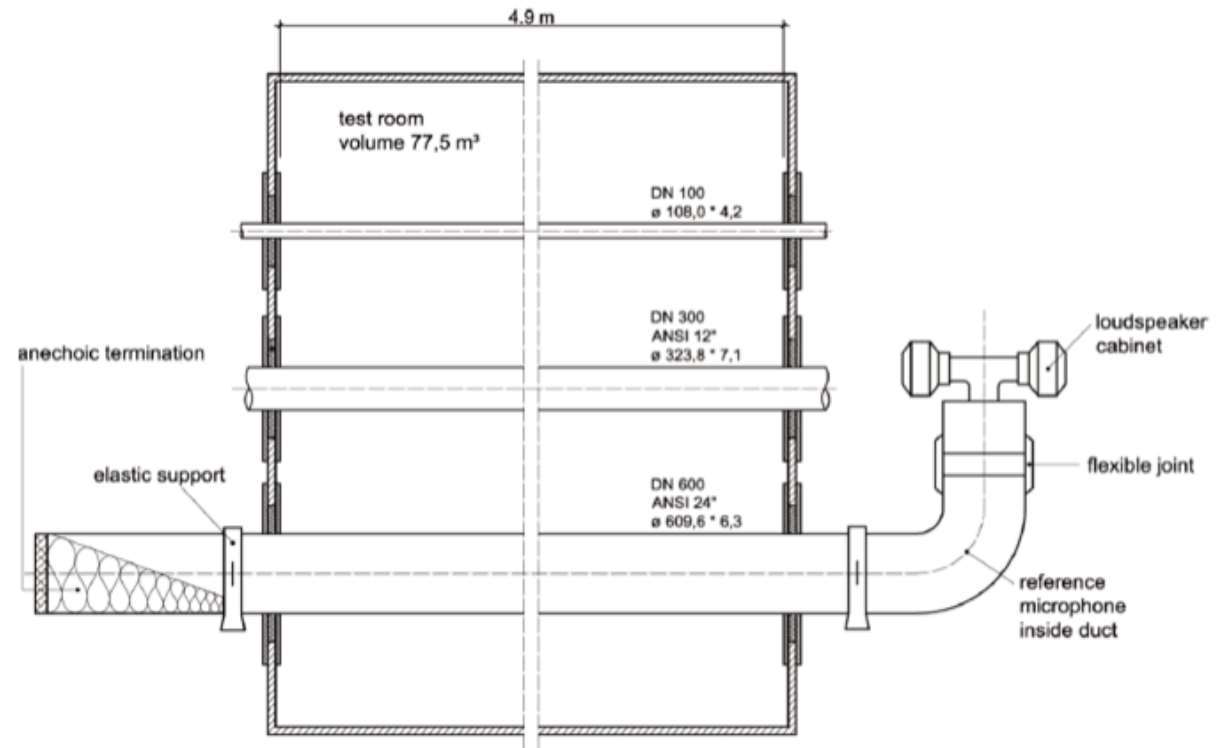

**Schematic of the test arrangement used to measure insertion loss to ISO 15665:2003 method.**

## Acoustic insulation properties of FireMaster pipe fire protection system

**Table 1:**  
**Third octave Band Insertion Loss (dB)**  
 measured for FireMaster Marine Plus Blanket 128 kg/m<sup>3</sup>  
 applied on pipes

Insulation System	Pipe	Frequency (Hz)							
		63	125	250	500	1000	2000	4000	8000
FireMaster Marine Plus Blanket <b>50mm + 0.6mm steel cladding</b>	DN 100	-8	-12	-6	1	13	20	23	32
	DN 300	-5	-6	-7	3	13	25	29	41
	DN 600	-4	-4	-5	3	1	21	35	44
FireMaster Marine Plus Blanket <b>50mm + 1mm steel cladding</b>	DN 100	2	-3	1	6	11	12	27	36
	DN 300	-2	-6	-5	1	8	20	26	39
	DN 600	-2	-4	-5	2	10	19	33	42
FireMaster Marine Plus Blanket <b>75mm + 0.8mm steel cladding</b>	DN 100	3	0	-6	4	10	21	33	42
	DN 300	-7	-16	-4	2	13	26	31	36
	DN 600	-6	-9	-2	5	20	30	42	37
FireMaster Marine Plus Blanket <b>100mm + 0.6mm steel cladding</b>	DN 100	-10	-16	-7	5	13	21	28	33
	DN 300	-7	-7	-1	5	15	26	32	50
	DN 600	-9	-14	0	13	27	33	46	47



**Typical test arrangement  
 of pipes tested insulated  
 with the FireMaster pipe  
 fire protection system**

**Table 2:**  
**Third octave Band Insertion Loss (dB) measured**  
**for FireMaster Marine Plus Blanket 128 kg/m<sup>3</sup>**  
**and anti-drumming compound applied on pipes**

Insulation System	Pipe	Frequency (Hz)							
		63	125	250	500	1000	2000	4000	8000
FireMaster Marine Plus Blanket <b>50mm + 0.6mm steel cladding</b>	DN 100	-8	-12	-6	1	13	20	23	32
FireMaster Marine Plus Blanket <b>50mm + 0.6mm steel cladding</b> <b>+ 3mm anti-drumming compound</b>		-5	-4	-4	3	12	27	33	35
FireMaster Marine Plus Blanket <b>75mm + 0.8mm steel cladding</b>	DN 300	-7	-16	-4	2	13	26	31	36
FireMaster Marine Plus Blanket <b>75mm + 0.8mm steel cladding</b> <b>+ 3mm anti-drumming compound</b>		-8	-7	-2	5	16	31	37	32
FireMaster Marine Plus Blanket <b>75mm + 0.8mm steel cladding</b>	DN 600	-6	-9	-2	5	20	30	42	37
FireMaster Marine Plus Blanket <b>75mm + 0.8mm steel cladding</b> <b>+ 3mm anti-drumming compound</b>		-4	-9	-1	8	25	35	44	39



## Acoustic insulation properties of FireMaster pipe fire protection system

**Table 3:**  
**Third octave Band Insertion Loss (dB)**  
**measured for FireMaster Marine Plus Blanket 128 kg/m<sup>3</sup>**  
**with and without cladding applied on pipes**

Insulation System	Frequency (Hz)								
	Pipe	63	125	250	500	1000	2000	4000	8000
FireMaster Marine Plus Blanket <b>50mm no cladding</b>	DN 600	-1	-5	-6	3	12	23	35	32
FireMaster Marine Plus Blanket <b>50mm + 0.6mm steel cladding</b>	DN 600	-4	-4	-5	3	11	21	35	44
FireMaster Marine Plus Blanket <b>50mm + 1mm steel cladding</b>	DN 600	-2	-4	-5	2	10	19	33	42

### Important note on testing result values

Frequencies of 63dB and 125db are below the lower frequency range of the test room used according to ISO 3741. The measured insertion loss values in the tables have been increased by 3dB accordingly as specified in the test report.

The frequency of 250dB is close to the frequency limit for the test room and the measured insertion loss values in the tables have been increased by 1dB from the measured results, again as specified in the test report.

### Sound Transmission Classes ISO 15665:2003

The minimum insertion loss required to meet each class is given below for reference only. In referencing these classes, the following information should be considered.

1. The primary purpose of FireMaster Marine Plus blanket is to provide fire insulation and not to meet a specific sound transmission classification.
2. In order to achieve jet fire resistance, the choice of cladding material required to meet fire protection requirements may not be optimal for acoustic purposes.
3. When designing fire protection solutions, thickness of insulation varies according to critical pipe temperature rise limits (with varying operating temperatures) and pipe section factor. It may not be possible to comply with sound insulation class limits in all octave bands. As the outer diameter of the insulation system increases due to higher thickness of fire insulation, insertion loss may become worse in very low frequency octave bands for example.
4. The spectral class limits defined in ISO 15665:2003 are specified for general pipe assemblies not taking into account the specific composition of the actual sound emissions for operating process. For example, for high frequency noise from gas pipes the insertion loss values at low frequencies would be of negligible importance.

Class	Pipe Min Diameter (mm)	Pipe Max Diameter (mm)	Frequency (Hz)						
			125	250	500	1000	2000	4000	8000
A1		< 300	-4	-4	2	9	16	22	29
A2	≥ 300	< 650	-4	-4	2	9	16	22	29
A3	≥ 650	< 1000	-4	-5	3	11	21	35	44
B1		< 300	-9	-3	3	11	19	37	35
B2	≥ 300	< 650	-9	-3	6	15	24	33	42
B3	≥ 650	< 1000	-7	2	11	20	29	36	42
C1		< 300	-5	-1	11	23	34	38	42
C2	≥ 300	< 650	-7	4	14	24	34	38	42
C3	≥ 650	< 1000	-1	9	17	26	34	38	42



**FIREMASTER®**



# Explosion resistance testing of FireMaster® Process Equipment fire protection systems



The following systems were tested for explosion resistance at the DNV-GL Spadeadam test site in 2015:

- FireMaster Vessel Fire Protection System
- FireMaster RES System installed onto a 3 inch schedule xxs pipe
- FireMaster Pipe Fire Protection System
  - o 3inch schedule 40 pipe insulated with two alternative insulation specifications:
    - 76mm FireMaster Marine Plus Blanket + 40mm of Microporous flexible (total outside diameter of pipe 322mm)
    - 38mm FireMaster Marine Plus Blanket + 76mm Microporous flexible (total outside diameter of pipe 306mm)



**Pipes and RES system installed in explosion chamber prior to explosion testing.**



**FireMaster vessel system installed on back wall of explosion chamber prior to explosion testing.**



# Explosion resistance testing of FireMaster® Process Equipment fire protection systems

The specimens were subjected to two consecutive explosions with the following overpressures

Test	Average Overpressure (mbar)	Average Duration (ms)
1	430	170
2	500	170

After each test the specimens were examined and assessed for integrity of the fire protection system.

Test Sample	Assessment of Damage	
	Test 1	Test 2
FireMaster Pipe 1	Some deformation of the end caps	Some deformation of the end caps
FireMaster Pipe 2	Some deformation of the end caps	Some deformation of the end caps
FireMaster RES	Some deformation of the end caps RES box rotated 90°	Some deformation of the end caps. Loss of some rivets near centre of pipe
FireMaster Vessel System	No damage or deformation of FireMaster blanket	No damage or deformation of FireMaster blanket



**FireMaster Vessel system after 2nd explosion test. No damage occurred to the cladding. An inspection of the insulation was made after removal of the cladding and no damage or compression of the insulation thickness was noted.**



**RES system after second explosion test.**



**Pipe system after second explosion test.**